

SELF-SENSITIZATION OF PHOTO-OXYGEN EVOLUTION IN Ag^+ ZEOLITES: COMPUTER-CONTROLLED EXPERIMENTS

GION CALZAFERRI, STEPHAN HUG, THOMAS HUGENTOBLER and BARBARA SULZBERGER

Institute for Inorganic and Physical Chemistry, University of Bern, Freiestrasse 3, CH-3000 Bern 9 (Switzerland)

(Received November 29, 1983)

Summary

For several years we have known that aqueous dispersions of Ag^+ zeolites are able to produce oxygen under illumination. Recently we have been successful in measuring the self-sensitization of photo-oxygen evolution in these systems. When we tried to study this phenomenon in more detail by applying conventional photochemical methods, we ran into severe experimental problems because series of complex experiments had to be carried out for several days without interruption.

To overcome these problems we then decided to build a computer-controlled experiment. In the present paper we describe our initial experimental results. Because our experimental design was found to be very flexible and easily adaptable to different problems, we explain it in detail.

1. Introduction

For some years we have been engaged in studying the properties of heterogeneous photoredox systems, e.g. aqueous dispersions of metal-cation-exchanged zeolites [1 - 5]. Recently we have detected self-sensitization of photochemical oxygen evolution in aqueous dispersions of Ag^+ zeolites [1, 2]. This means that dispersions which are initially insensitive to visible light become photoactive after they have been illuminated for a few minutes with light of a higher energy. The process of self-sensitization is expected to occur not only in Ag^+ zeolites but also in many other metal cation systems in which the metal cation can be photoreduced to the metal atom. Therefore, we decided to study the self-sensitization reactions in more detail. It was found that with conventional photochemical equipment it was not possible to obtain sufficiently good information. Some experiments required 100 or more illumination and dark periods, each of approximately 30 min. Several parameters had to be measured and others had to be controlled during the entire duration of the experiments. The only way to fulfil these requirements was to build a computer-controlled experiment.

Computerized photoexperiments of this complexity have not yet been reported. Furthermore, our approach was found to be of great flexibility. Therefore we give a detailed description in Section 3.

When aqueous Ag^+ zeolite dispersions are irradiated, oxygen is produced and the Ag^+ ions are reduced [1 - 6]. Under the same conditions, in the presence of Cl^- , chlorine is produced instead of oxygen [1, 4, 5]. Recently, we have reported the pH dependence of photo-induced oxygen evolution in an aqueous dispersion of an Ag^+ zeolite A which was irradiated at 360 nm [2]. The properties of these systems can depend very strongly on the type of zeolite framework [7]. An example is the pH dependence of the photo-oxygen evolution of Ag^+ mordenite $\text{Ag}_{0.8}\text{H}_{7.2}[(\text{AlO}_2)_8(\text{SiO}_2)_{40}] \cdot 24\text{H}_2\text{O}$ in contrast with that of $\text{Ag}_{9.7}\text{Na}_{2.3}[(\text{AlO}_2)_{12}(\text{SiO}_2)_{12}] \cdot 24\text{H}_2\text{O}$ which is observed in Ag^+ zeolite A. The behaviour of the Ag^+ mordenite is shown in Fig. 1. A dispersion of 0.28 g of Ag^+ mordenite in 100 ml of water was irradiated through a monochromator at 360 nm with a 200 W mercury high pressure lamp. The experimental conditions were exactly the same as reported in ref. 2. The pH changes were made by adding either 0.1 N H_2SO_4 or 0.1 N NaOH . The oxygen signal (in microlitres) corresponds to the oxygen evolved during an illumination period of 5 min with a light flux of approximately $33 \mu\text{W cm}^{-2}$. The irradiated area was 35 cm^2 .

Instead of a maximum sensitivity between pH 6 and pH 7, as observed in the Ag^+ zeolite A [2], we see a sudden increase from approximately zero sensitivity below pH 6 to a maximum sensitivity above pH 9. From our present knowledge, the overall stoichiometry of this photo-oxygen generation can be described by the following scheme:

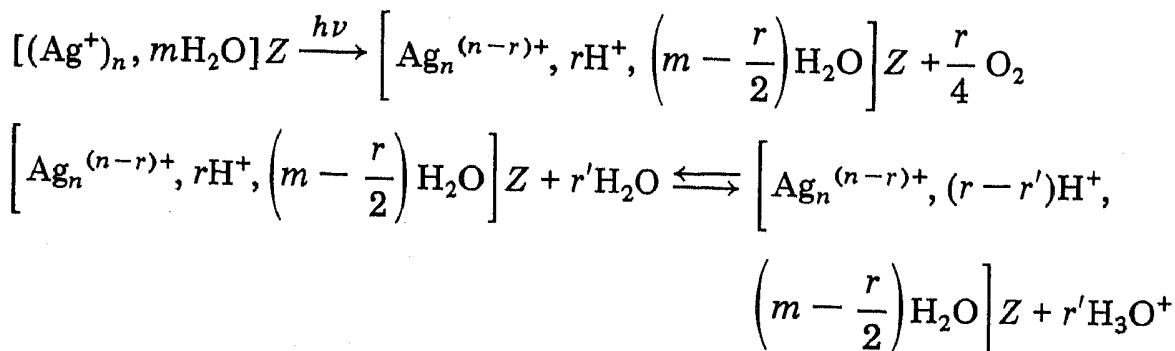

where Z represents the negatively charged zeolite lattice [7]. These equations predict that oxygen evolution and a decrease in pH occur together. Figure 2 shows that this is indeed the case. 0.2 g of Ag^+ zeolite A was dispersed in 100 ml of water. The experimental conditions were as described in ref. 2. When an Ag^+ zeolite A is dispersed in water we always observe an increase in pH. This is probably due to partial hydrolysis of the Ag^+ ions. For this reason the experiment shown in Fig. 2 started at approximately pH 8. The system was irradiated through a broad band interference filter K36 at 360 nm. The light flux was approximately $330 \mu\text{W cm}^{-2}$.

The total amount of oxygen produced in this experiment was $463 \mu\text{l}$. From the corresponding change in the pH we deduce that only a fraction of the protons appears as H_3O^+ , the other protons remain in the zeolite

OXYGEN

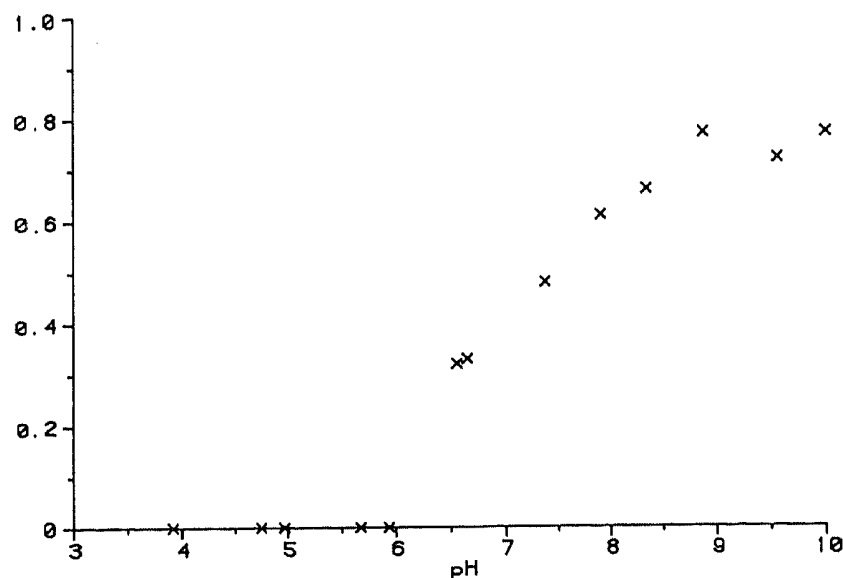

Fig. 1. pH dependence of photo-oxygen evolution of an aqueous dispersion of Ag^+ mordenite.

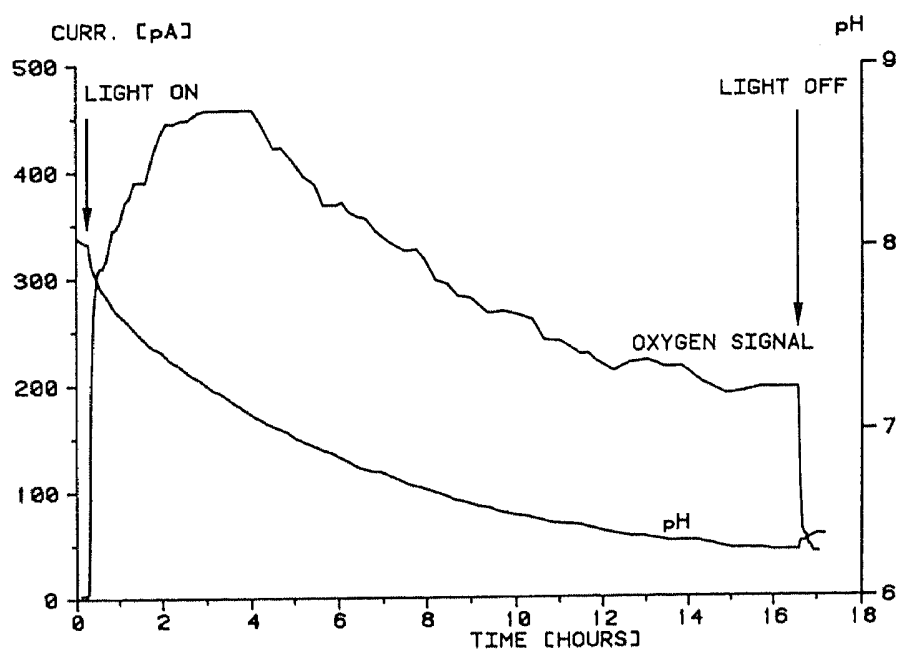

Fig. 2. Photo-oxygen generation and corresponding pH dependence of an aqueous Ag^+ zeolite A. The total oxygen evolution in this experiment was $463 \mu\text{l}$.

framework. The measured amount of photoproduced silver(0) corresponds to the oxygen evolved within the experimental error of around 10%.

2. Self-sensitization of oxygen evolution

During our photochemical studies on Ag^+ zeolites we have observed that systems which were initially insensitive to visible light became photoactive

after illumination at 350 - 380 nm [1, 2]. This means that self-sensitization occurs. We believe that the process of self-sensitization does not only occur in these systems but is also of general importance. To obtain quantitative information about this process, a sophisticated photoexperiment had to be designed. The initial results of our studies are shown in Figs. 3 and 4. In both cases 0.3 g of Ag^+ zeolite A $\text{Ag}_{11}\text{Na}[(\text{AlO}_2)_{12}(\text{SiO}_2)_{12}] \cdot 24\text{H}_2\text{O}$ was dispersed in oxygen-free distilled water. Nitrogen was bubbled through the solution until the residual current of the oxygen sensor was stable and below 1 nA and no longer interfered with our measurements.

We shall first explain Fig. 3. Each cycle was started with oxygen detection. After 2 min the shutter was opened and the system was illuminated with light of 530 nm. The slit width of the monochromator was 20 nm. After 8 min of illumination the shutter was closed and the dispersion remained in the dark for 22 min. This dark period of 22 min was chosen to

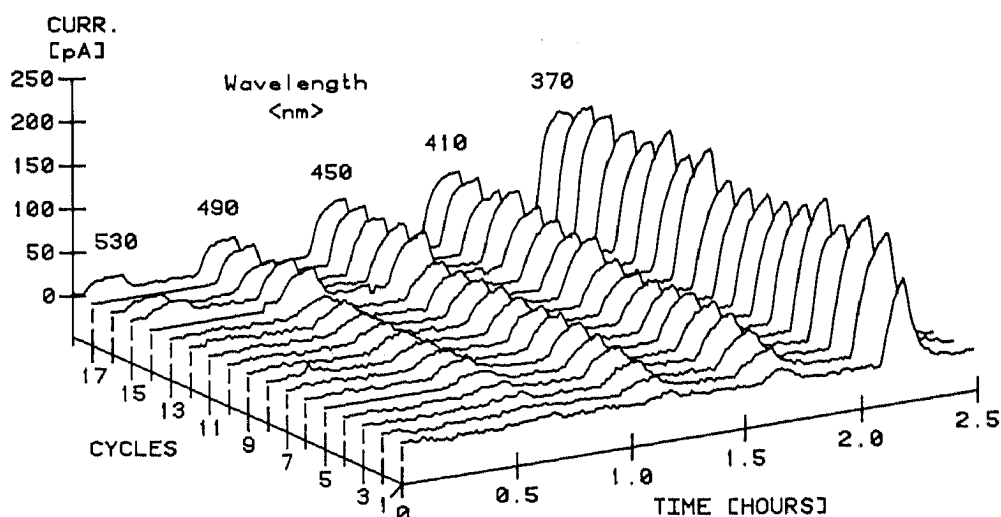

Fig. 3. Self-sensitization experiment of an aqueous Ag^+ zeolite A dispersion. (1 nA s corresponds to 6.82 nl of oxygen.)

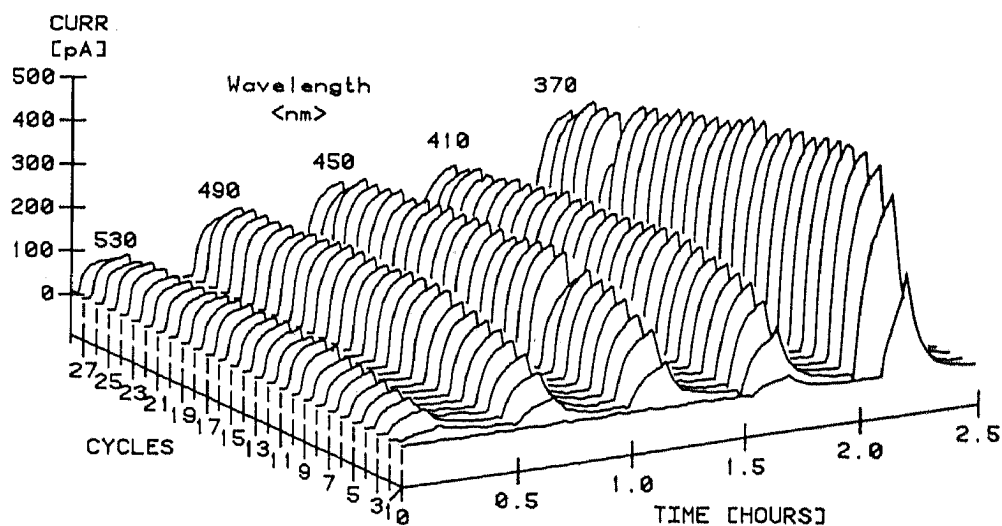

Fig. 4. Self-sensitization experiment of an aqueous Ag^+ zeolite A dispersion. (1 nA s corresponds to 3.94 nl of oxygen.)

allow the oxygen signal to decay back to the baseline. During the dark period the monochromator was set to 490 nm and several parameters were measured. Afterwards the system was illuminated again for 8 min. During the dark period the monochromator was set to 450 nm. After the first cycle was finished, we started cycle 2 without delay and then cycle 3 etc. After 18 cycles had been completed, we stopped the experiment. Throughout the duration of the experiment the pH was kept "manually" between 5 and 6 by adding small portions of 0.1 N NaOH. This manual adjustment was found to be unsatisfactory because of the strong pH dependence. Therefore, we introduced an automated pH adjustment in the later experiments. The energy flux on the irradiated surface of 35 cm² was kept constant at 4.3 mW for all wavelengths. This means that the ratio between the photon fluxes for the different wavelengths from 530 to 370 nm was equal to 1:0.92:0.82:0.77:0.7. For experimental reasons we kept the energy flux constant and not the photon flux.

The main differences in the next experiment (Fig. 4) are the light flux which was twice as high (9.1 mW), the slit width of the monochromator which was 30 nm and the pH which was automatically controlled to be always between 6 and 6.3. It might be asked why we did not apply a buffer system instead of using a relatively complicated pH adjustment. The reason is that all buffer systems interfere with the photochemical properties of Ag⁺ zeolites, whereas small amounts of Na⁺ ions do not.

Both experiments show that initially the Ag⁺ zeolite is completely photo-inactive above 410 nm. After it has been irradiated once at 370 nm it becomes sensitive at longer wavelengths. In Fig. 5(a) the integral of the oxygen produced at each wavelength in a cycle is drawn *versus* the cycle number and in Fig. 5(b) we show the total amount of oxygen produced in an entire cycle *versus* the cycle number. The information refers to the same experiment as that of Fig. 4.

From these results we conclude that we have now clear experimental evidence that self-sensitization does occur. The rate of this process seems to depend non-linearly on the light flux. We have found that a very high light intensity is unfavourable.

A reasonable explanation of the self-sensitization process is that first silver atoms and later silver clusters are formed, which act as chromophores. As we deduce from the dependence on the light intensity, an optimal growing rate seems to exist. We do not know more about the photochemical system than its degree of reduction [8]. More experimental information is needed. Experiments as shown in Figs. 3 - 5 have only become possible by applying modern computer techniques. Because of this progress in photochemical experimental techniques and because of the fast growing knowledge of "ligand-free" metal clusters [9], of metal clusters in zeolites [10] and of "naked" metal clusters [11], we believe that a semiquantitative understanding of such reactions will become possible very soon. Therefore, the field of heterogeneous photoreactions will expand very rapidly.

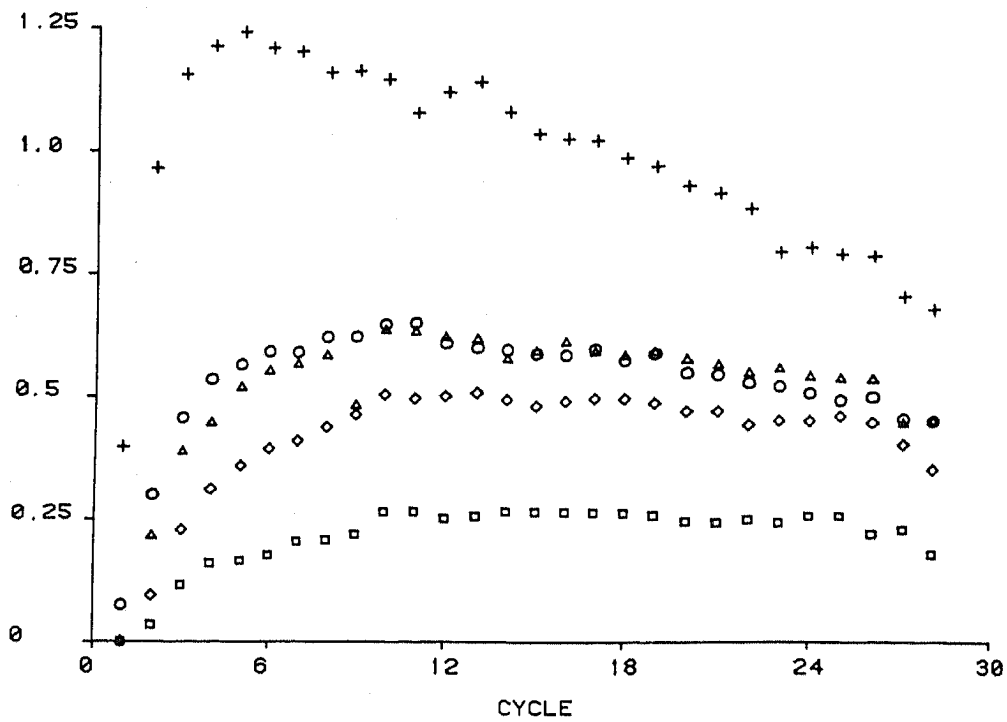
μ l OXYGEN

(a)

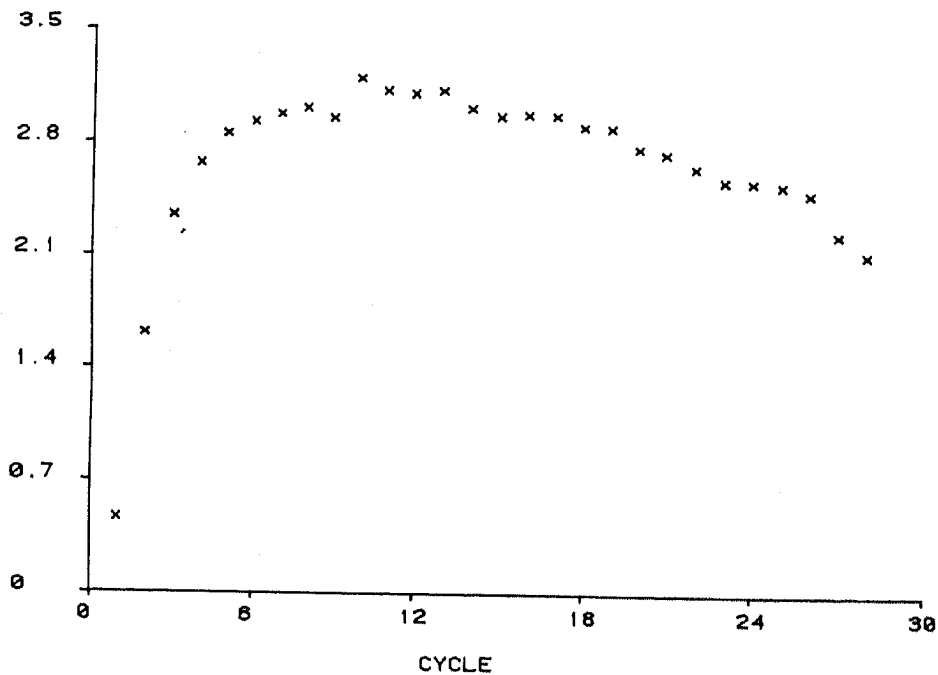
 μ l OXYGEN

(b)

Fig. 5. (a) Oxygen produced at various wavelengths in each cycle vs. the cycle number (+, 370 nm; O, 410 nm; Δ, 450 nm; ◇, 490 nm; □, 530 nm); (b) oxygen produced in a complete cycle vs. the cycle number.

3. Computer-controlled photoredox experiments

To obtain the results reported in Figs. 3 - 5, the experiments had to be run for 3 - 4 days without interruption. During this time the procedure

explained in Fig. 7 had to be completed at each wavelength. Let us look at the experimental set-up (Fig. 6) before we explain this procedure. Many aspects of this experiment are the same as those already reported in an earlier paper [2], but far better developed. The photoreactor PR which is kept at constant temperature is illuminated from below. The nitrogen flow is controlled by means of a double-needle valve VN. The oxygen sensors O2 are Clark electrodes [2]. One sensor is immersed in the solution and the other is in the gas phase. The remote-controlled microburette Microlab P Hamilton RB is used either for the calibration of the oxygen detectors or for the computer-controlled addition of NaOH. pH denotes a pH electrode. The photoreactor containing 100 ml of the dispersion under investigation is surrounded by a black box. With the shutter SH closed, the system remains in the dark. When SH is open, the system can be illuminated, depending on the position of the mirror MR. The mirror MR is used to guide the light into the photoreactor or onto the thermopile TP. The light coming from the 450 W xenon lamp LA passes through the monochromator MC. Approximately 10% of the monochromatic light is guided by a beam splitter BS to a photodiode PD which is used for the feedback control FB of the power supply PS of the lamp. The larger fraction of the light goes to the mirror MR. The light flux is held constant by means of two regulation circuits. The photodiode is connected directly to the feedback unit of the power supply. This circuit area has a fast response and eliminates short-time fluctuations of the xenon arc. As the photodiode has a wavelength-dependent response, the feedback level must be corrected on each different wavelength to maintain a constant light flux through the spectrum. This is performed by means of a thermopile which has a flat response. The thermopile signal is transmitted to the computer and compared with the pre-set value.

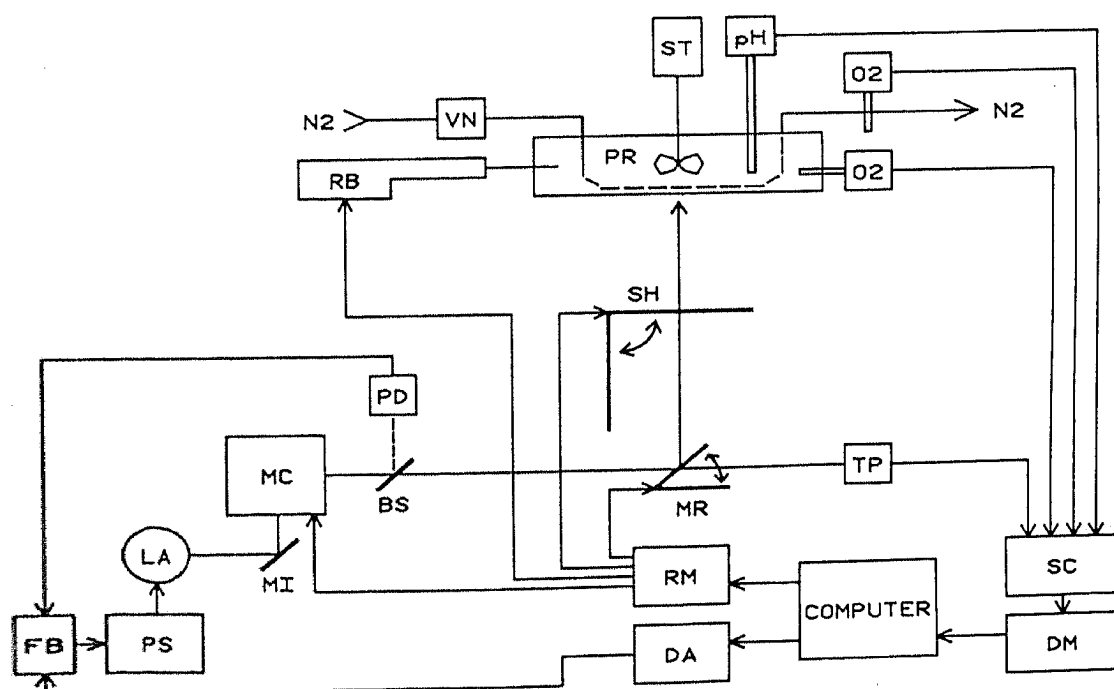

Fig. 6. Experimental set-up (see text).

DA is a digital-to-analog converter HP 59501 which is used to control the feedback of the power supply. RM is a home-built programmable relays matrix. It is used to control the stepper motors of the monochromator and the remote-controlled burette. It also moves the shutter SH and the mirror MR. The electrical signals are fed into an analog scanner SC which is connected to a DM Schlumberger 7060 digital multimeter. The minicomputer PDP 11/05 controls the multimeter DM, the relays matrix RM and the analog-to-digital converter DA by a GPIB interface. The control programs are written in Tektronix SPS BASIC which is a very appropriate language for this type of application. The data are stored on floppy disks.

We can now explain the measurement procedure shown in Fig. 7. It is divided into three tasks: data acquisition; computer-controlled tasks; control and regulation functions.

The figure has to be read from left to right.

The light flux is measured by means of the thermopile and compared with a pre-set value. The feedback level is then iteratively changed until the correct value is reached. Because of the slow response of the thermopile this process takes about 90 s. The pH value is measured and the mirror is moved to reflect the light to the photoreactor. At a pre-set time the oxygen detection is started. After 2 min the shutter is opened for exactly 8 min and the photoreactor is illuminated. Then oxygen detection is continued until the oxygen signal has relaxed to the baseline which takes less than 15 min. Exactly 26 min after starting the oxygen detection the measurement is stopped. The mirror is moved and the light flux is measured for control with the thermopile. If necessary the pH value is corrected by adding 0.1 N NaOH. Depending on the pH drift this takes about 1 - 3 min. After the data have been stored and some calculations have been performed, the monochromator is moved to the next wavelength and the whole process is repeated.

In a recently published paper we have explained the calibration of Clark electrodes [2]. Reference 2 contains experimental information for

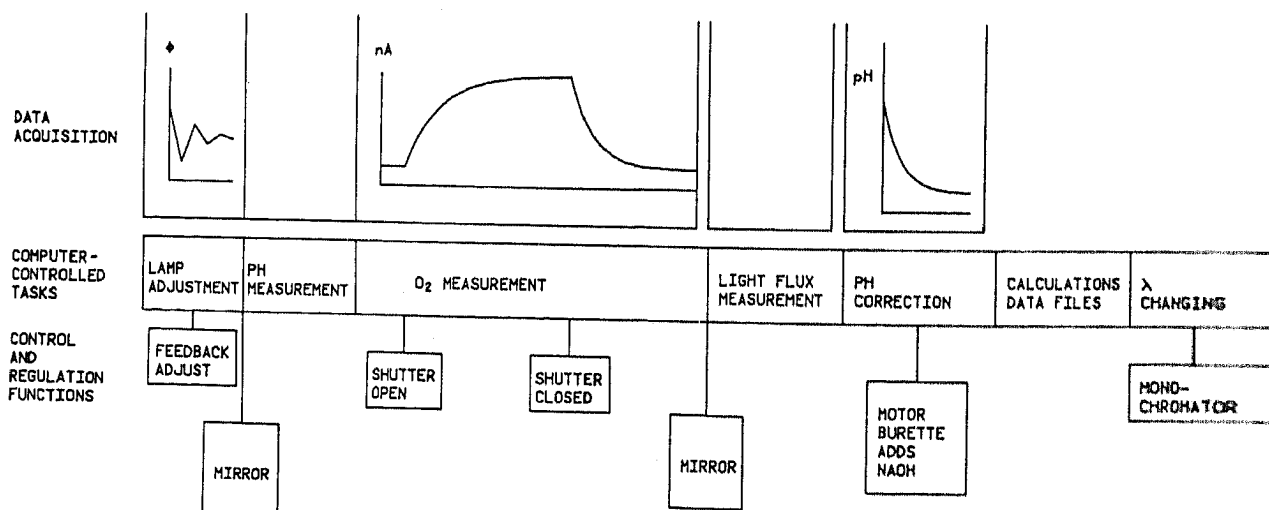

Fig. 7. Experimental flow at each wavelength.

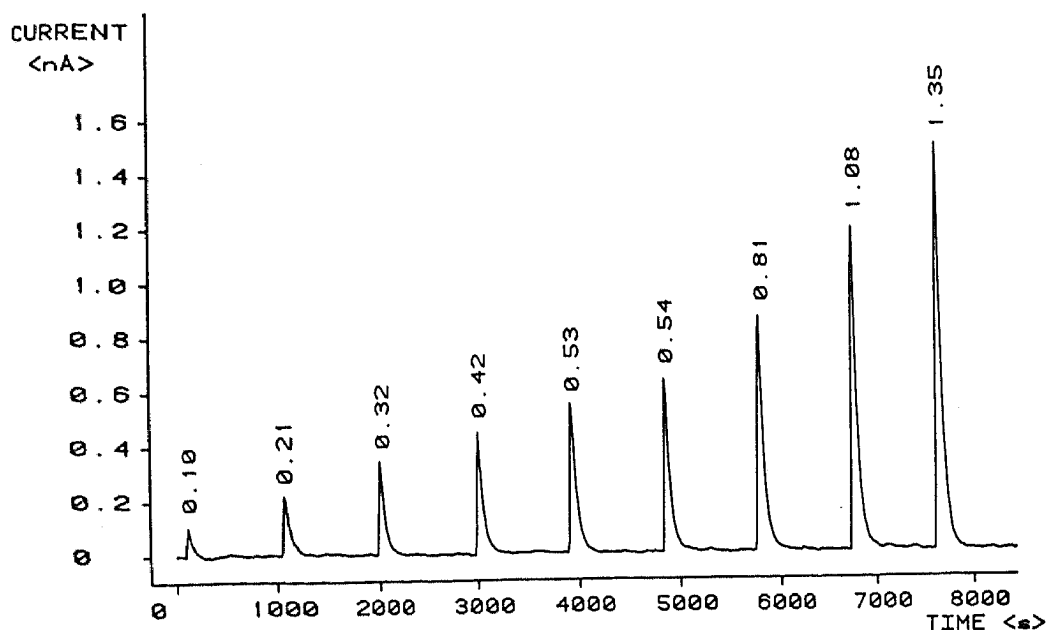

Fig. 8. Calibration signals of the Clark electrode. (The numerals on each peak indicate the number of microlitres of oxygen.)

electrodes in the gas phase. The data for electrodes immersed in a solution are similar but obviously the time response is faster. We have found a very simple but powerful method of suppressing the residual current of the electrodes and therefore to increase their sensitivity in a way which to our knowledge has never been reported in the literature. In Fig. 8 we show a typical calibration curve of electrodes in solution. The calibration procedure is the same as that already reported [2]. Instead of injecting air we inject oxygen-saturated water. The main difference is that the electrodes are put together under oxygen-free conditions; this means that the electrolyte used in the electrode is also oxygen free. This simple trick helps us to acquire stable and sensitive electrodes quickly. It is important to maintain constant stirring.

Acknowledgments

We would like to thank Metrohm AG., Herisau, for financial support and we appreciate the stimulating contacts with Dr. P. Rach. This paper is part of projects NP 4.399.080.04 and NR 2.901-0.83, financed by the Swiss National Foundation. We are especially grateful to Professor Dr. E. Schumacher for his encouragement.

References

- 1 B. Sulzberger, Experimente zur photochemischen Energiespeicherung mit metallbeladenen Zeolithen, *Doctoral Thesis*, University of Bern, Bern, 1983.

- 2 B. Sulzberger and G. Calzaferri, *J. Photochem.*, 19 (1982) 321.
- 3 E. Schumacher, *Chimia*, 32 (1978) 193.
S. Leutwyler and E. Schumacher, *Chimia*, 31 (1977) 475.
- 4 G. Calzaferri, *Chimia*, 32 (1978) 241; 35 (1981) 209.
- 5 G. Calzaferri, in E. Rabini (ed.), *Photochemical Conversion and Storage of Solar Energy 1982*, Part A, Weizmann Science Press, Jerusalem, 1982, p. 81.
- 6 P. A. Jacob, J. B. Uytterhoeven and K. J. Beyer, *J. Chem. Soc., Chem. Commun.*, (1977) 128.
- 7 D. W. Breck, *Zeolite Molecular Sieves*, Wiley, London, 1974.
W. M. Meier, *Molecular Sieves*, Society of the Chemical Industry, London, 1968, pp. 10 - 27.
R. M. Barrer, *Zeolites and Clay Minerals as Sorbents and Molecular Sieves*, Academic Press, London, 1978.
- 8 G. Calzaferri and J. Baumann, *J. Phys. Chem. N.F.*, 118 (1979) 129.
- 9 G. A. Ozin and S. A. Mitchell, *Angew. Chem.*, 95 (1983) 706.
- 10 G. A. Ozin, M. D. Baker and J. M. Parnis, *Angew. Chem.*, 95 (1983) 813.
- 11 A. Herrmann, S. Leutwyler, E. Schumacher and L. Wöste, *Helv. Chim. Acta*, 61 (1978) 453.
A. Herrmann, E. Schumacher and L. Wöste, *J. Chem. Phys.*, 68 (1978) 2327.
A. Herrmann, M. Hofmann, S. Leutwyler, E. Schumacher and L. Wöste, *Chem. Phys. Lett.*, 62 (1979) 216.
M. M. Kappes, R. W. Kunz and E. Schumacher, *Chem. Phys. Lett.*, 91 (1982) 413.